

PRODUCT CATALOGUE

etop-rank.com

TOP-RANK HEALTH CARE CO.,LTD.

Factory

Mashan Village, Dongguan Street, Shangyu District, Shaoxing City, Zhejiang P.R.China 312352 / 5th Floor,
Building 1, VSIP Industrial Park, Bac Ninh City, Vietnam Tel: +86(575)82563666 Fax: +86(575)82563750

Office

Room2008, 20/F, Block A, China Resources Building, 1366 Qianjiang Road, Hangzhou P.R.C(310020)
Tel: +86(571)87601069 Fax: +86(575)82670000





WHAT CAN WE DO ?

Top-Rank Healthcare Co., Ltd, founded in 2000, is a global leader in comprehensive rehabilitation therapy solutions. Specializing in medical rehabilitation supplies for pain relief, beauty fitness, and sports medicine, the company has modern production bases in Vietnam and Zhejiang, covering 30,000 square meters.

It holds several national and international certifications, including certifications such as ISO 13485, ISO 14001, MDSAP, CE, FDA, UKCA, and Health Canada for electrode patches, marking it as one of the most certified enterprises in the sector.

2000
Founded

60+
Patents

100K
Cleanroom

30000m²
Modernized production base

20+
Qualification Certificates



24 Years of Experience



CDMO Service
Tailored to Your Needs



Medical-Grade Standards
Precision Quality Control



Digital Manufacturing

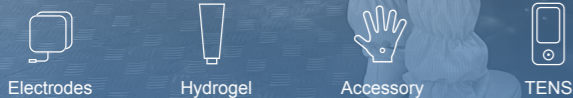

Customizable Options
Flexible AED Pad Choices



Patented Development
Innovative Formula for Safety



CONTENTS

ELECTRODE

- Cdmo Service
- Standard Therapy Electrodes
- Special Therapy Electrodes
- Other Pads

TENS DEVICE

- TENS-806
- Custom Case

HYDROGEL

- Cdmo Service
- Hydrogel Series
- Conductive Gel
- Custom Case

LEAD WIRES

- Lead Wires





ELECTRODE

CDMO SERVICE



Material

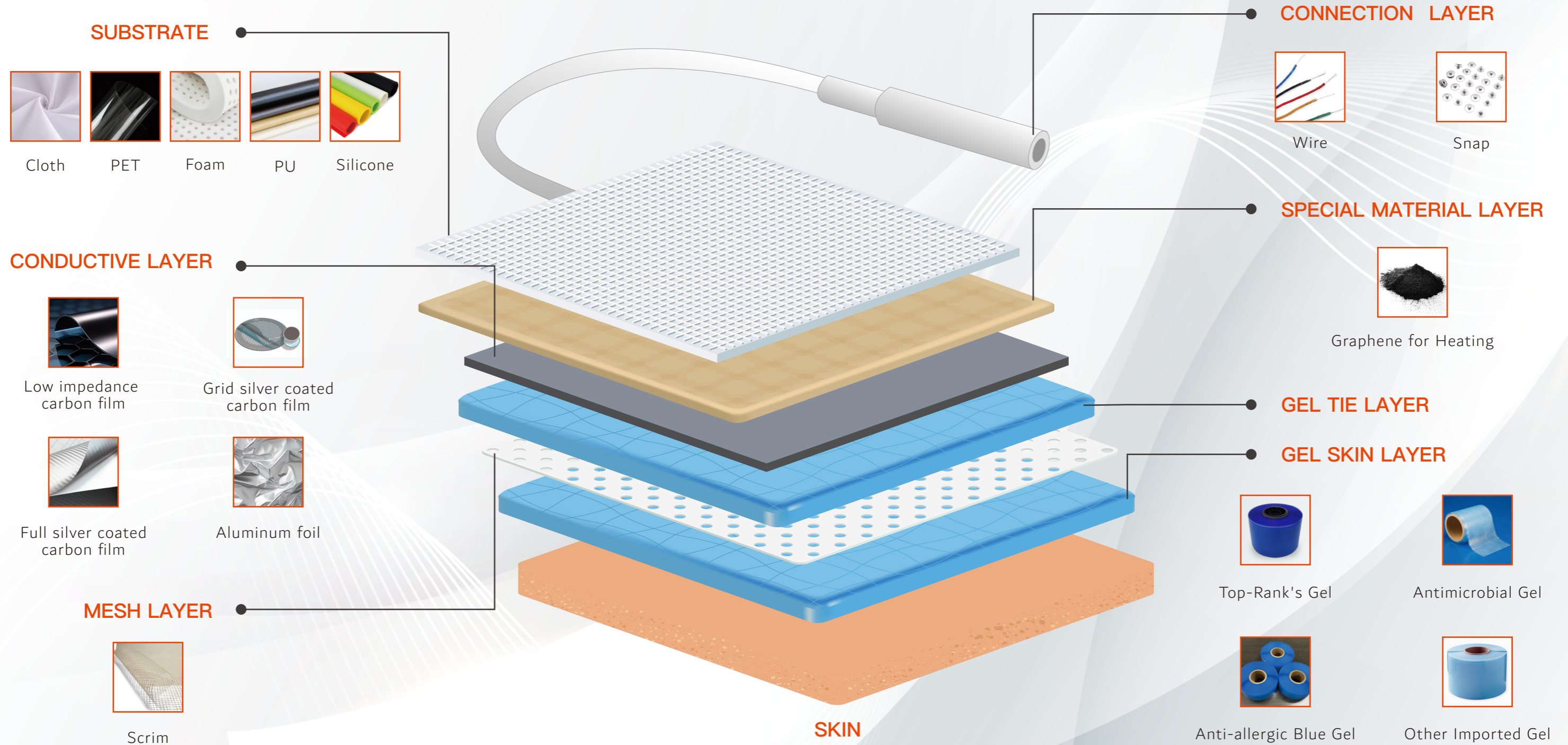

Printing

Substrate Printing

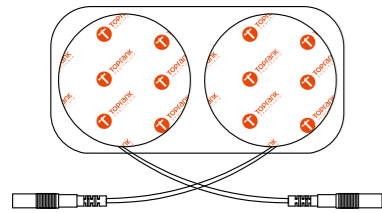

Full-page printing

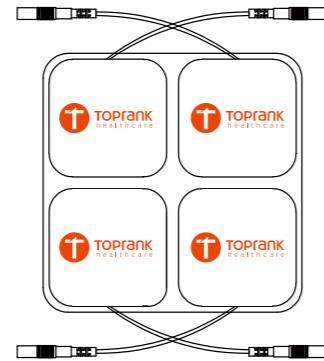

Position printing

Polyethylene Terephthalate Release Film Printing



Bottom plate logo printing

Conductive Layer Printing



Full silver coated carbon film

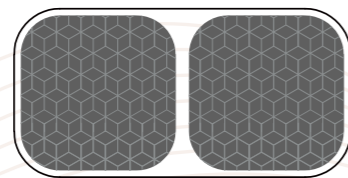

Grid silver coated carbon film

Packaging

PE Bag



Printed version



Cardboard version

Aluminum Foil Bag



Printed version



Sticker version

Paper-aluminum Bag



Printed version





STANDARD THERAPY ELECTRODES

Electrodes are used in conjunction with multiple physiotherapy devices, as a non-pharmacological, non-invasive method of pain relief by stimulating the perceptual nerves with a mild micro-currents to block the transission of nerve signals to achieve pain relief.

Applications

- Osteoarthritis
- fibromyalgia
- tendonitis
- bursiti
- postnatal rehabilitation
- low back pain
- chronic disease-related neuropathy
- etc.

Features

- Efficient
- Reusable
- Compatible
- Customizable

Product Specification

Item	Shape	Size(mm)	Package(pcs/pack)
Wired electrode pad	Rectangle	30*50	4
	Rectangle	40*60	2
	Rectangle	40*80	2
	Rectangle	40*100	2
	Rectangle	40*150	2
	Rectangle	40*350	2
	Rectangle	50*90	2
	Rectangle	50*100	2
	Rectangle	70*120	2
	Rectangle	75*100	2
	Rectangle	75*150	2
	Rectangle	100*200	2
	Square	40*40	2/4/6
	Square	44*44	4
	Square	45*45	2
	Square	46*46	2
	Square	48*48	2/4
	Square	50*50	4
	Round	25	4
	Round	32	4
Round	45	4	
Round	50	4	
Round	70	1	
Round	75	1	
Snap electrode pad	Rectangle	50*100	2
	Square	45*45	4
	Square	40*40	4
	Square	50*50	4



SPECIAL THERAPY ELECTRODES

Providing Sophisticated ODM/OEM Services.

Shape	Size(mm)	Applicable Areas	Illustration
Oval	49*72/40*80/ 50*100/70*130	Shoulder, Inner and Outer Limbs	
Butterfly	110*150/93*150/ 130*88	Shoulder, Waist, Lower Leg	
Rectangle Gourd	40*350	Thigh, Spine, Lower Back	
Crescent	55*90	Joint, Waist, Upper Arm, Sole of the Feet	
Composite	61*36.43	Behind the Ear	
Electrode Pads	50*50/50*100/48 *75/28*40	Neck, Upper Arm, Abdomen, Shoulder, etc.	
Irregular	/	Face	
	/	Head	
	/	Eye	

Shape	Size(mm)	Applicable Areas	Illustration
Circular	/	Chest	
Irregular	/	Throat	
Flower	φ 150 round	Knee	
Trapezoidal, Butterfly	/	Perineal	
Irregular	100*150	Thigh, Back, Abdomen	
Bone	166*99	Muscle	
Oval	98*40	Joint	
Gourd	50*110	Shoulder, Neck	
Circular with Handles	φ 50	Shoulder, Neck	
Apple	76*165	Shoulder, Neck	



OTHER ELECTRODES

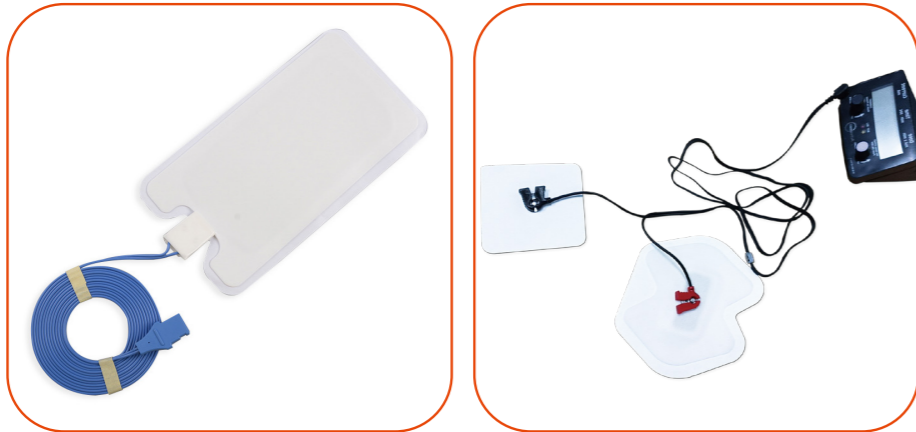

OEM/ODM
customization service



Non-irritating
design



Excellent Adhesion



Easy to use

Defibrillation Pad

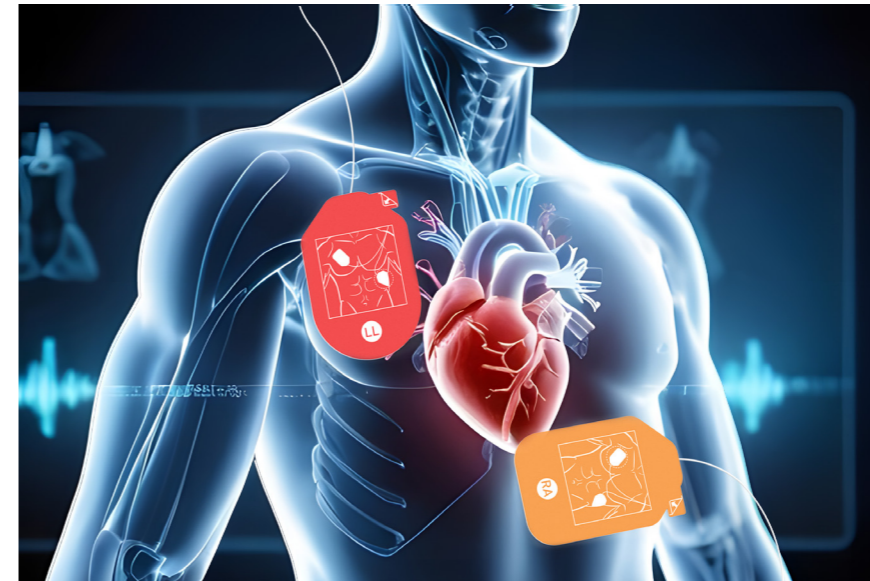

This product is for external defibrillation, cardioversion, non-invasive pacing, and ECG monitoring in adults, used in clinical settings, ambulances, and emergencies.

Features

- Flexible materials choices
- Clear placement images
- Continuous monitoring



Cooling Electrode

Lidocaine and menthol have been added to the electrode pad, constricting capillaries, reducing local congestion, lowering nerve sensitivity, and rapidly relieving pain.



Heating Electrode

It is a medical device that uses heat therapy to relieve pain, relax muscles, and reduce joint discomfort for faster recovery.

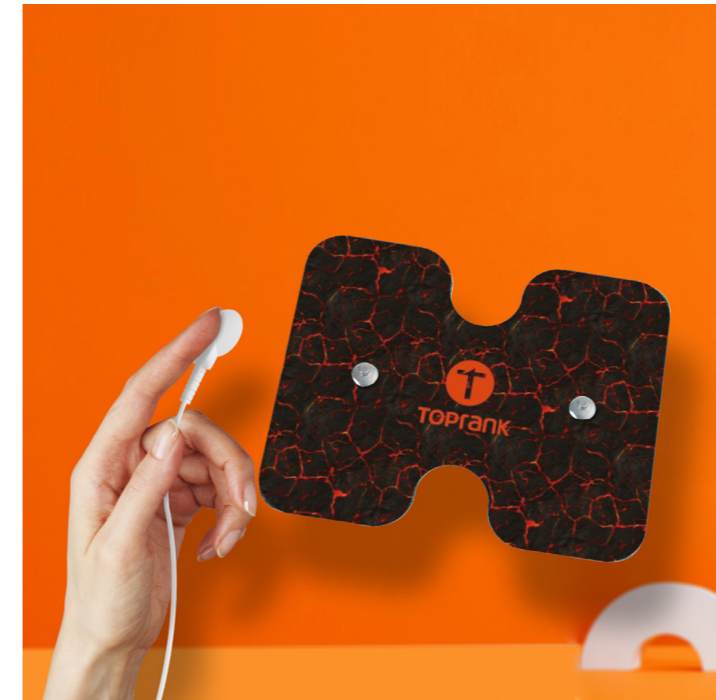

Features

- 4% lidocaine and 1% menthol
- Highly durable
- Targeted electrotherapy

Features

- Heats up in seconds
- Universal compatibility
- Customizable



Grounding Pad

It is a single-use neutral electrode that provides a return path for high-frequency electrosurgical generators, promoting low current density to safely direct current and prevent burns.



Features

- Fits various electrosurgical and RF units
- Safety pad with gel on metal foil edge
- Large surface area promotes low current density

Iontophoresis Electrodes

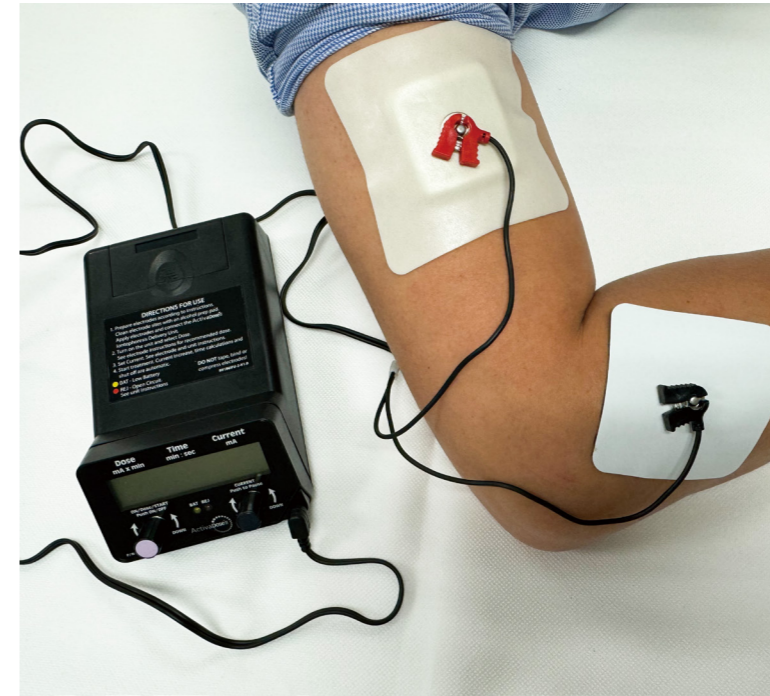

Iontophoresis electrodes are drug delivery pads that transmit ionized drugs through skin using a device, ensuring effective transdermal drug delivery with host-driven currents.

Features

- 4 different signal electrode pieces
- Ion introduction method for drug delivery
- Drug delivered through the skin



HYDROGEL



CDMO SERVICE

Product Image Description

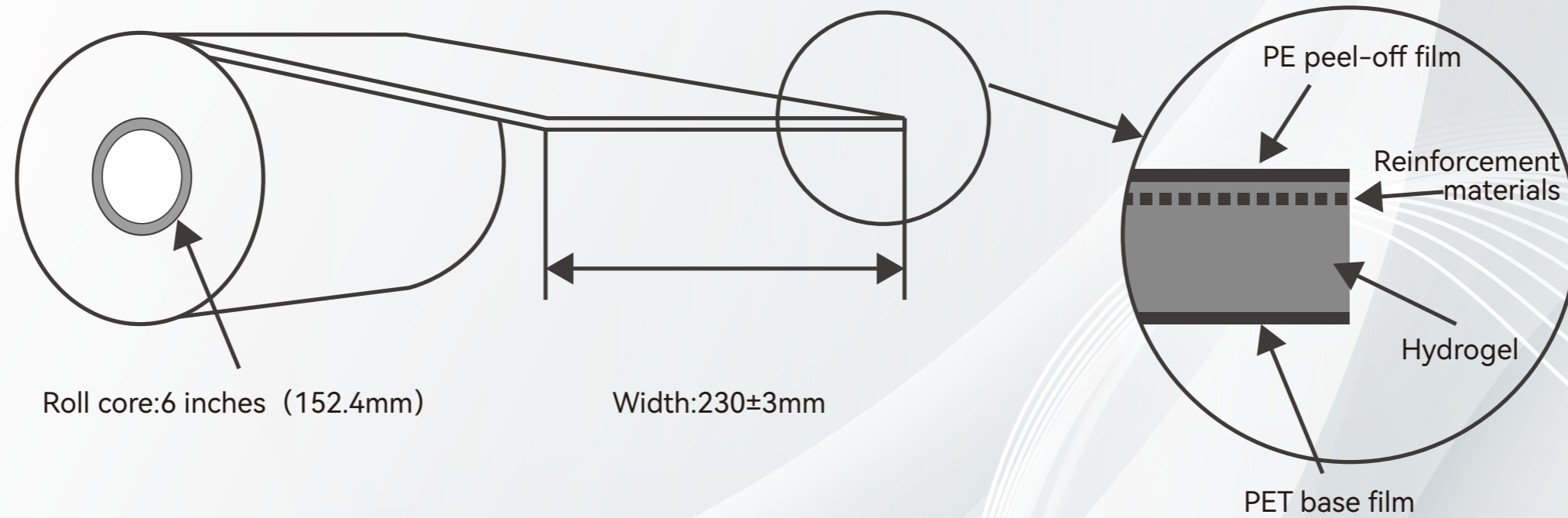

Application



Medical Electrodes



Aesthetic Medicine



Medical Dressings

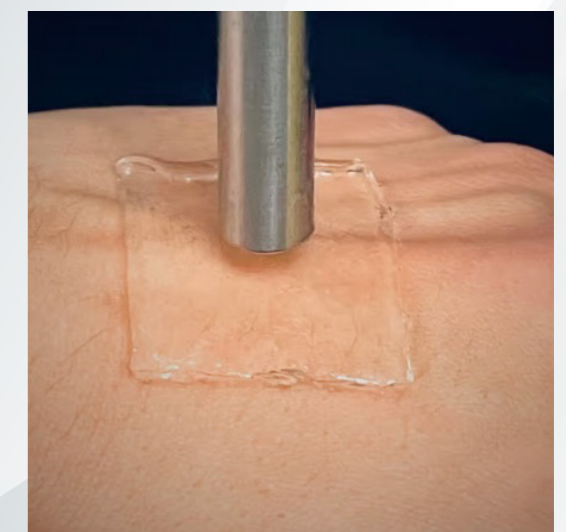

Specialty Medical Gels

The adhesion and ingredient of the hydrogel can be customized according to different application scenarios.

HYDROGEL SERIES



Product Specification

Our hydrogel solutions address specific needs like stimulation, sensing, defibrillation, grounding pads, iontophoresis, skincare, wound care, and custom formulations.



Features

- Safe ingredients
- Skin-friendly
- Independently developed

Models	Specifications Thickness(T) Width (w) Length(L)	Impedance	Re-using Times	Washability
MH051	T:0.85±0.1mm W:230±1mm L:100m/Roll	<130Ω	More Than 30 Times	Washable
MH051+/C	T:0.85±0.1mm W:230±1mm L:100m/Roll	<130Ω	More Than 100 Times	Washable
MH051/CM	T:0.85±0.1mm W:230±1mm L:100m/Roll	<130Ω	More Than 30 Times	Washable
MH052	T:0.85±0.1mm W:230±1mm L:100m/Roll	<130Ω	1-5Times	nonwashable
MH053	T:0.85±0.1mm W:230±1mm L:100m/Roll	<130Ω	1-5Times	nonwashable
MH055	T:0.85±0.1mm W:230±1mm L:100m/Roll	<130Ω	Reusable	Washable
MH056	T:0.85±0.1mm W:230±1mm L:100m/Roll	<130Ω	Reusable	nonwashable
MH011	T:0.65±0.1mm W:180±1mm L:100m/Roll	<50Ω High- frequencyimpedance	Single-use	nonwashable
MH031	T:0.85±0.1mm W:230±1mm L:100m/Roll	<130Ω	Single-use	nonwashable
MA011	T:0.85±0.1mm W:230±1mm L:100m/Roll	N/A	N/A	nonwashable



CONDUCTIVE GEL

TOP-RANK's electrotherapy conductive gel is used with TENS and EMS therapy. Conductive gel is used externally to reduce the impedance of the electrode surface in contact with the skin.



Product Specification

Serial Number	Item No	Bottle type	Volume	Package
01	TG-65ML		65ml/2.3oz	200pcs/carton, Carton dimension: 43cm*36cm*28cm, Gross weight: 14.5kgs
02	TG-90ML		90ml/3.2oz	160pcs/carton, Carton dimension: 43cm*36cm*28cm, Gross weight: 16kgs
03	TG-100ML		100ml/3.5oz	160pcs/carton, Carton dimension: 48cm*40cm*33cm, Gross weight: 17.5kgs
04	TG-150ML		150ml/5.3oz	160pcs/carton, Carton dimension: 48cm*40cm*33cm, Gross weight: 17kgs
05	TG-250ML		250ml/8.9oz	50pcs/carton, Carton dimension: 40cm*30cm*30cm Gross Weight:17kgs

Features

- High conductive
- Water-based gel
- Increase electrode adhesion





CUSTOM CASE

Hydrogel For Heel Pads

Experience ultimate relaxation and rejuvenation with our hydrogel for heel pads. Designed to soothe tired feet, this innovative hydrogel formulation provides deep hydration and comfort.



Hydrogel For Grounding Pad

The grounding pad hydrogel provides consistent electrical conductivity during surgery, preventing instrument-related injuries.





TENS DEVICE

TENS-806

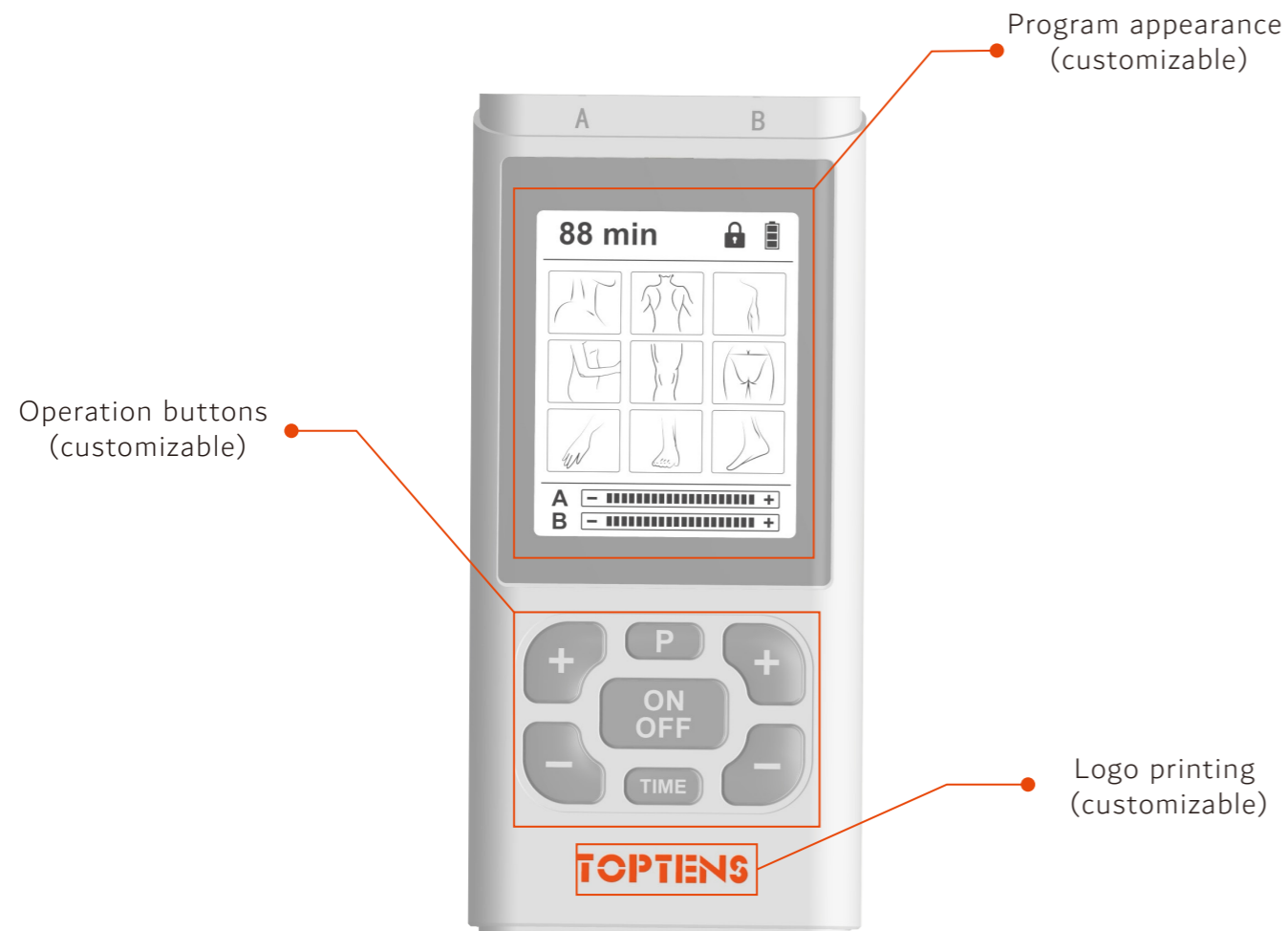

Packaging Accessories (customizable)



Product Specification

Mode	Output Mode	Frequency(Hz)	Pulse width
Mode 1	Frequency Modulation	60-100	100-150
Mode 2	Frequency Modulation	100-150	200
Mode 3	Frequency Modulation	80-100	260
Mode 4	Continuous wave	120	100-150
Mode 5	Pulse Width Modulation	100-150	100
Mode 6	Frequency Modulation	100	100
Mode 7	Continuous wave	60-100	100
Mode 8	Continuous wave	100	100-160
Mode 9	Frequency Modulation	100	260

Applications

- Neck/Back/Shoulder
- Elbow/Knee/Hip
- Wrist/Foot/Ankle

Features

- 9 Stimulation Modes
- 20 Intensity Levels
- Independent Dual Channels



CUSTOM CASE

COGGIX Muscle Fascia Massage Device

Accessory Showcase

Deep relaxation anywhere
Unlock a new code for health
Open up a new realm of wellness
Professional technology care

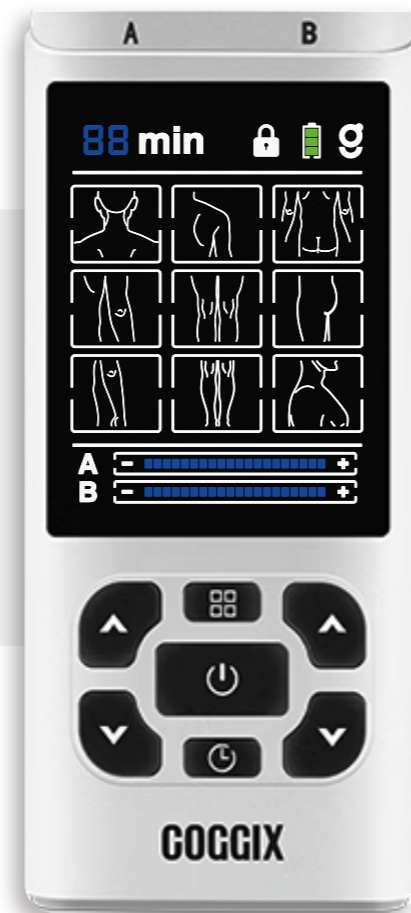

Features

- Default 30-minute pulse treatment
- 20 adjustable intensity levels
- Deep relief from stiffness and soreness



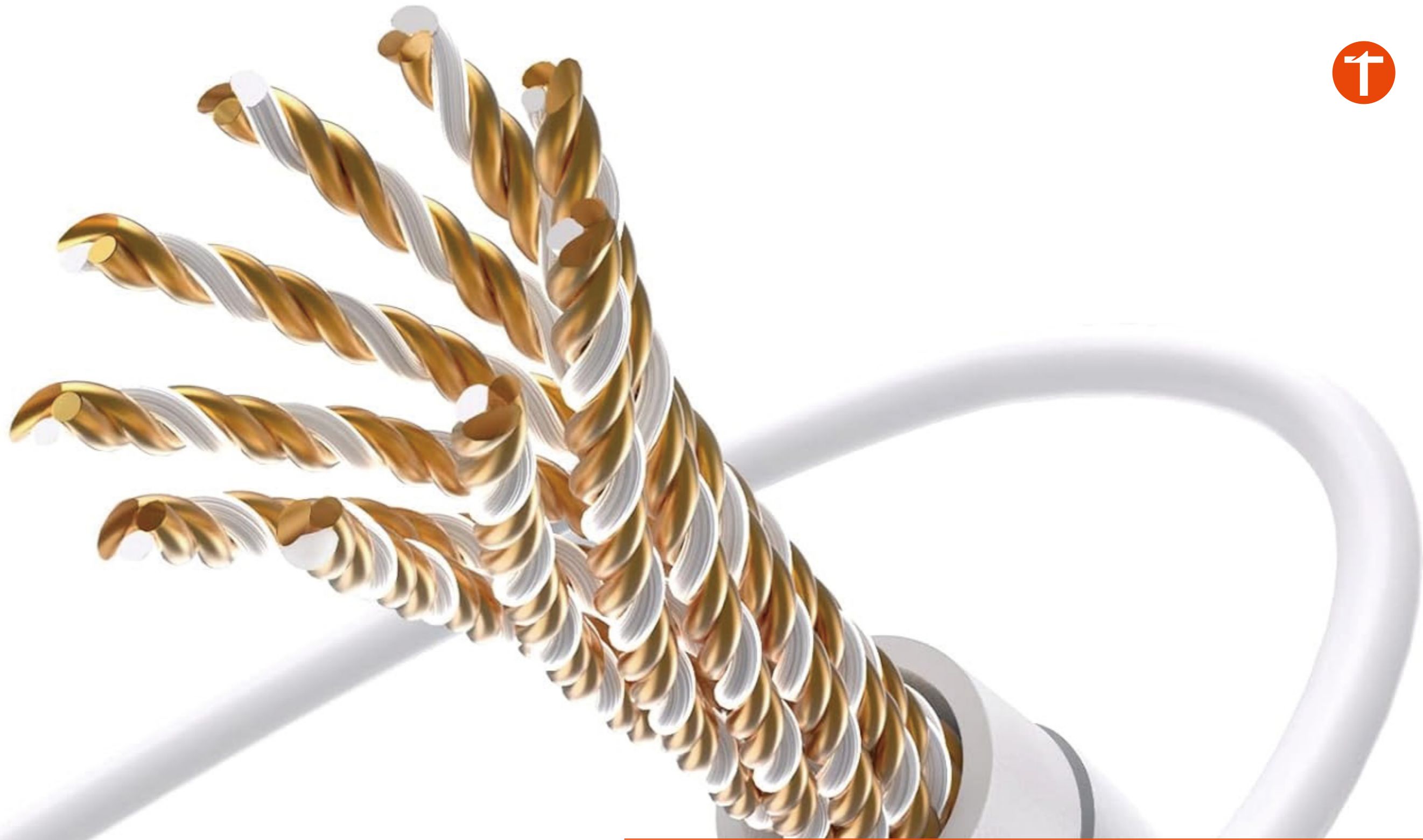

LEAD WIRES



LEAD WIRES

The lead wires are specifically designed for TENS machines, EMS machines, and medium to high-frequency devices with electrode pads, ensuring effective treatment through efficient transmission of electrical signals.



Applications

- The lead wire is specifically designed for use with TENS, EMS, or other low and medium frequency therapy devices, as well as ECG equipment.

Features

- Pure copper and PVC jacket
- The plastic materials used pass the California 65 test
- Highest intensity, durable, soft and flexible

Plug



Safety Plug : φ 2.0



Safety Plug : φ 2.35



Safety Plug : φ 2.5



Safety Plug : φ 3.5



Audio Plug : φ 2.5



Audio Plug : φ 3.5



Male Snap : φ 3.4



6Pin Plug



Type C Plug



MK Plug

Connector



Female Snap : φ 2.2



Female Snap : φ 2.8



Female Snap : φ 3.5



Medical Snap : φ 4.0



Pin : φ 2.0

Plugs and connectors can be matched in any combination. Other sizes, shapes, colors, and lengths of wire are also available.